

Listing and Technical Evaluation Report™

Report No: 1507-03



Issue Date: September 10, 2015
Revision Date: December 11, 2023
Subject to Renewal: January 1, 2025

BamCore® Prime Wall™ System

Trade Secret Report Holder:

Global Bamboo Technologies Inc.

Phone: 707-737-0288

Website: www.bamcore.com

CSI Designations:

DIVISION: 06 00 00 - WOOD, PLASTICS AND COMPOSITES

Section: 06 12 00 - Structural Panels

Section: 06 16 00 - Sheathing

Section: 06 17 00 - Shop-Fabricated Structural Wood

1 Innovative Product Evaluated¹

1.1 BamCore® Prime Wall™ System

1.1.1 The BamCore® Prime Wall™ System is comprised of:

1.1.1.1 Bamboo Hybrid Prime Wall™ G3 Panels, or

1.1.1.2 Eucalyptus Super Combi Prime Wall™ Panels.

2 Product Description and Materials

2.1 The innovative product evaluated in this report is shown in **Figure 1**.

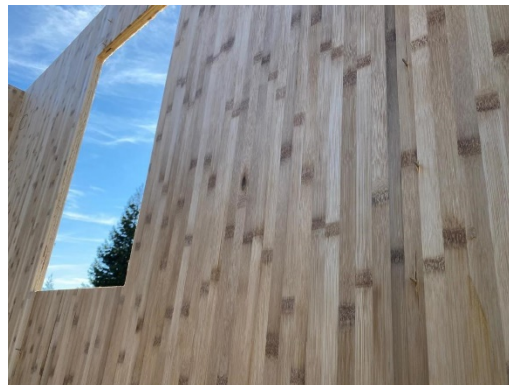

Figure 1. House Under Construction Using BamCore® Panelized Prime Wall™ System

2.2 The BamCore® Prime Wall™ System is comprised of two Bamboo Hybrid Prime Wall™ Panels or two Eucalyptus Super Combi Prime Wall™ Panels forming the interior and exterior faces of the wall assembly. The panels are fastened to wood plates at the top and bottom of the wall assembly and from one panel to the next contiguous panel, as specified by approved construction documents. Contiguous panels are fastened to each other using lap joints. Blocking between panels is added per specific job requirements.

2.3 Specifically, the BamCore® Prime Wall™ System consists of the following:

2.3.1 *BamCore® Prime Wall™ Panel Composition:*

2.3.1.1 Bamboo Hybrid Prime Wall™ Panels

2.3.1.1.1 These panels consist of multiple veneer layers covered with nominal 1/4" (6.4 mm) bamboo on both faces.

2.3.1.2 Eucalyptus Super Combi Prime Wall™ Panels

2.3.1.2.1 These panels consist of multiple veneer layers covered with nominal 1/4" (6.4 mm) Eucalyptus veneers on both faces.

2.3.1.3 The panels have a nominal thickness of 1 1/4" (32 mm) (see **Figure 2**).

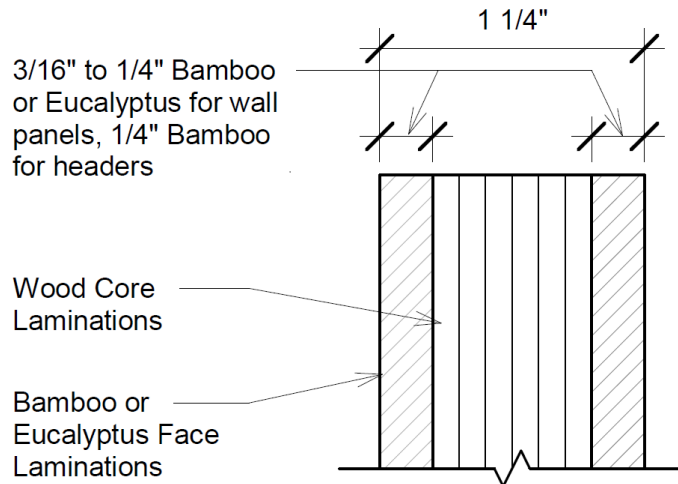

Figure 2. BamCore® Prime Panel Construction

2.3.1.4 The BamCore® Prime Wall™ System may be designed with plate widths that allow outer wall dimensions from 8" (203 mm) to 13 3/4" (349 mm).

2.3.1.5 Individual BamCore® Prime Wall™ Panels are manufactured with routed edges to form half lap joints at adjoining panel edges. The half lap joint is 1" (25 mm) wide; each panel has half their depth in the connection.

2.3.2 *Wood Top and Bottom Plates:*

2.3.2.1 The wood top and bottom plates shall be minimum of one 2x6 No. 2 dimensional lumber with a minimum oven-dry specific gravity of 0.50. Moisture content at the time of installation shall be nineteen percent (19%) or less. Preservative treated lumber installed with a moisture content greater than nineteen percent (19%) is permitted.

2.3.2.2 Bottom plates can be comprised of two 2x3 No. 2 dimensional lumber with a minimum oven-dry specific gravity of 0.50. Moisture content at the time of installation shall be nineteen percent (19%) or less. Preservative treated lumber installed with a moisture content greater than nineteen percent 19% is permitted.

2.3.2.3 Both the interior and exterior panels are connected to the wood plates with 0.131" dia. x 3 1/4" long (3.3 mm x 85 mm) smooth shank nails spaced per **Table 1** or **Table 2**. Install nails in the centerline of the 2x plates to maintain a minimum 3/4" (19 mm) edge distance along the top and bottom of the panels, as shown in **Figure 3**.

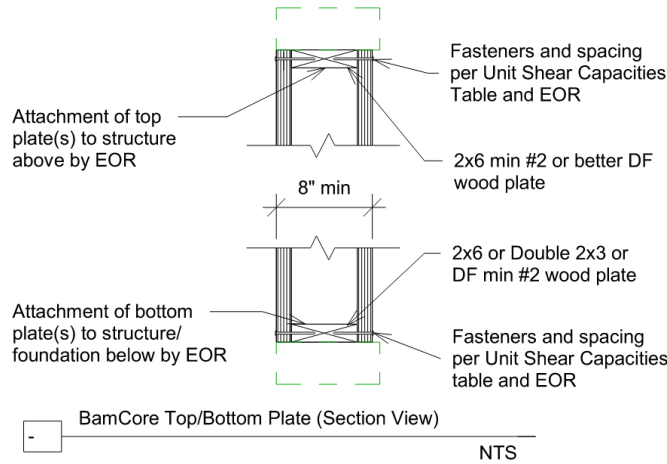

Figure 3. BamCore® Top/Bottom Plate

2.3.3 **Fastening:**

2.3.3.1 Contiguous panels within a shear wall shall be connected together at vertical joints with a half lap joint, as demonstrated in **Figure 4**.

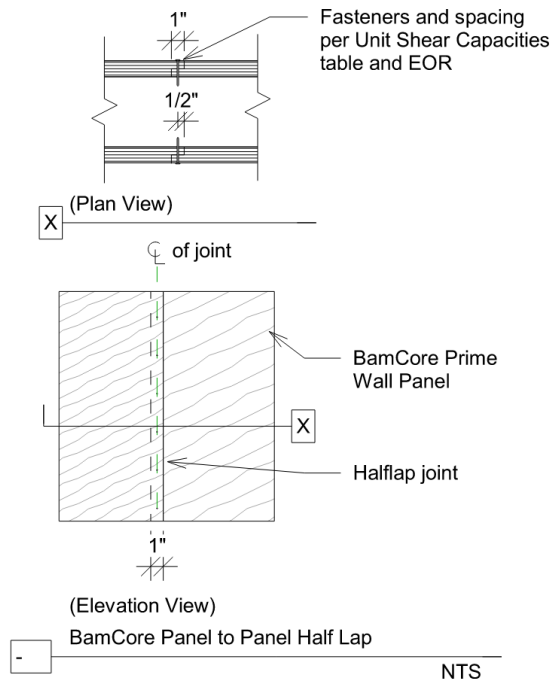

Figure 4. BamCore® Panel to Panel Half Lap

2.3.3.2 The half lap joint is 1" (25 mm) wide, and each panel has half their depth in the connection.

2.3.3.2.1 Up to 1/4" space in between adjacent panels is permitted. Fasteners at lap joints require 3/16" minimum edge distance.

2.3.3.2.2 For shear walls with solid sawn wood plates, the half lap joint shall be connected with 0.113" dia. x 2" long (2.9 mm x 50 mm) ring shank nails. Nails shall be spaced per **Table 1** and **Table 2**.

2.3.4 *Hold-Downs:*

2.3.4.1 For shear wall applications with solid sawn wood plates, hold-downs are composed of a partial height wood block nailed to each panel. A metal plate sits on top of the blocks and is attached to the foundation/framing below using a threaded rod. See **Figure 7** for attachment requirements.

2.3.4.2 Alternative hold-down options are given in **Table 2**.

2.3.5 *Blocking:*

2.3.5.1 Vertical panel blocking shall be installed in the cavity between the two runs of panels and fastened to the BamCore® Prime Wall™ panels using minimum 0.131" dia. x 3 1/4" long (3.3 mm x 85 mm) nails with spacing per **Table 7** (see **Figure 5**).

2.3.5.2 Blocking height and spacing depend on specific job requirements as specified in the approved construction documents.

2.3.5.3 Blocking around window/door openings are to be fastened using minimum 0.131" dia. x 3 1/4" long (3.3 mm x 85 mm) nails to match Vertical panel blocking nail spacing (6" o.c. [152 mm] maximum spacing) (see **Figure 6**).

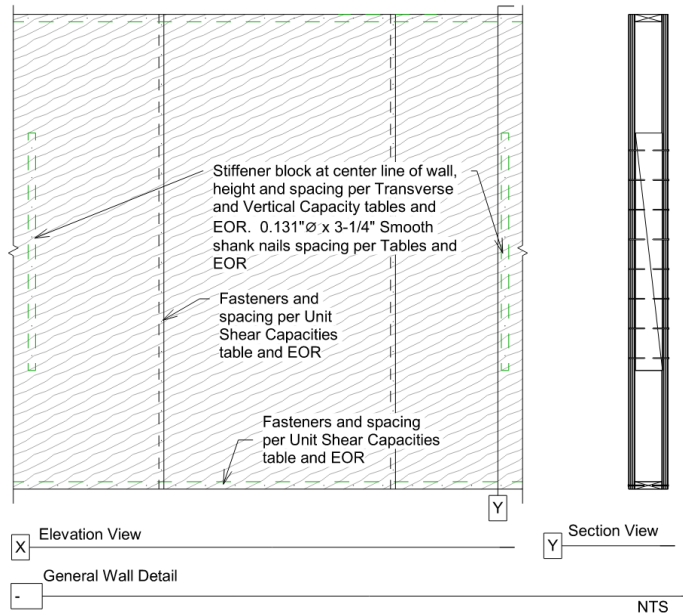

Figure 5. General Wall Detail

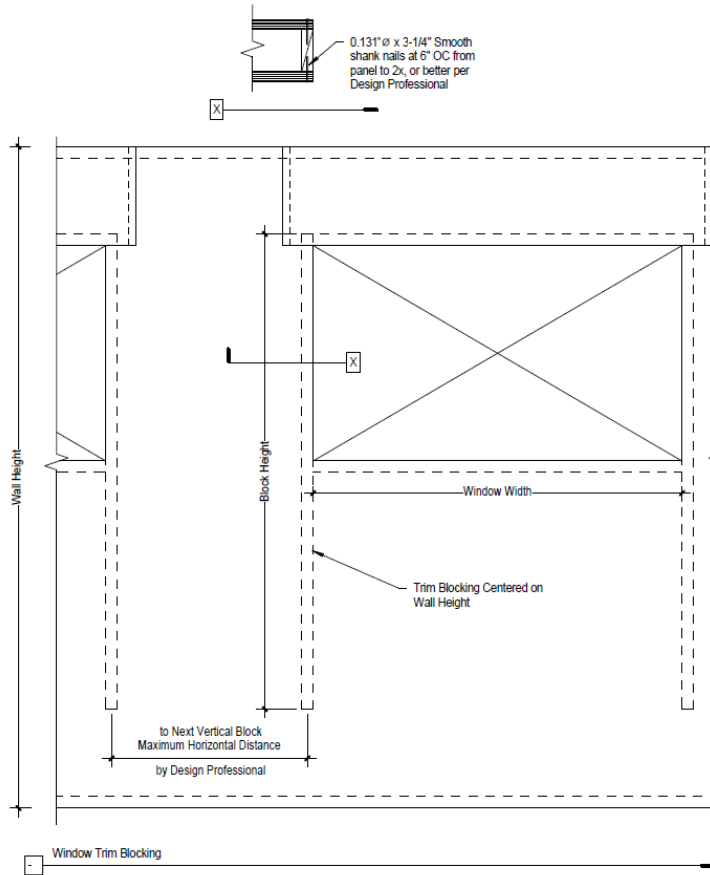

Figure 6. Window Trim Blocking

- 2.4 BamCore® Prime Wall™ Systems are prefabricated to a job-specific engineered plan and delivered to the jobsite with materials as specified in BamCore®-to-client contracts.
- 2.5 As needed, review material properties for design in Section 6 and to regulatory evaluation in Section 8.

3 Definitions

- 3.1 New Materialsⁱⁱ are defined as building materials, equipment, appliances, systems or methods of construction not provided for by prescriptive and/or legislatively adopted regulations, known as alternative materials.ⁱⁱⁱ The design strengths and permissible stresses shall be established by tests^{iv} and/or engineering analysis.^v
- 3.2 Duly Authenticated Reports^{vi} and research reports^{vii} are test reports and related engineering evaluations, which are written by an approved agency^{viii} and/or an approved source.^{ix}
 - 3.2.1 These reports contain intellectual property and/or trade secrets that are protected by the Defend Trade Secrets Act (DTSA).^x
- 3.3 An approved agency is “approved” when it is ANAB ISO/IEC 17065 accredited. DrJ Engineering, LLC (DrJ) is listed in the ANAB directory.
- 3.4 An approved source is “approved” when a professional engineer (i.e., Registered Design Professional [RDP]) is properly licensed to transact engineering commerce. The regulatory authority governing approved sources is the state legislature via its professional engineering regulations.^{xi}

- 3.5 Testing and/or inspections conducted for this Duly Authenticated Report were performed by an ISO/IEC 17025 accredited testing laboratory, an ISO/IEC 17020 accredited inspection body and/or a licensed RDP.
 - 3.5.1 The Center for Building Innovation (CBI) is ANAB^{xii} ISO/IEC 17025 and ISO/IEC 17020 accredited.
- 3.6 The regulatory authority shall enforce^{xiii} the specific provisions of each legislatively adopted regulation. If there is a non-conformance, the specific regulatory section and language of the non-conformance shall be provided in writing^{xiv} stating the nonconformance and the path to its cure.
- 3.7 The regulatory authority shall accept Duly Authenticated Reports from an approved agency and/or an approved source with respect to the quality and manner of use of new materials or assemblies as provided for in regulations regarding the use of alternative materials, designs or methods of construction.^{xv}
- 3.8 ANAB is an International Accreditation Forum (IAF) Multilateral Recognition Arrangement (MLA) signatory where recognition of certificates, validation and verification statements issued by conformity assessment bodies accredited by all other signatories of the IAF MLA with the appropriate scope, shall be approved.^{xvi} Therefore, all ANAB ISO/IEC 17065 Duly Authenticated Reports are approval equivalent.^{xvii}
- 3.9 Approval equity is a fundamental commercial and legal principle.^{xviii}

4 Applicable Standards for the Listing; Regulations for the Regulatory Evaluation^{xix}

4.1 Standards

- 4.1.1 *ANSI/AWC NDS: National Design Specification (NDS) for Wood Construction*
- 4.1.2 *ANSI/AWC SDPWS: Special Design Provisions for Wind and Seismic*
- 4.1.3 *ASCE/SEI 7: Minimum Design Loads and Associated Criteria for Buildings and Other Structures*
- 4.1.4 *ASTM C518: Standard Test Method for Steady-State Thermal Transmission Properties by Means of the Heat Flow Meter Apparatus*
- 4.1.5 *ASTM C1363: Standard Test Method for Thermal Performance of Building Materials and Envelope Assemblies by Means of a Hot Box Apparatus*
- 4.1.6 *ASTM D198: Standard Test Methods of Static Tests of Lumber in Structural Sizes*
- 4.1.7 *ASTM D5456: Standard Specification for Evaluation of Structural Composite Lumber Products*
- 4.1.8 *ASTM D5457: Standard Specification for Computing Reference Resistance of Wood-Based Materials and Structural Connections for Load and Resistance Factor Design*
- 4.1.9 *ASTM D7989: Standard Practice for Demonstrating Equivalent In-Plane Lateral Seismic Performance to Wood-Frame Shear Walls Sheathed with Wood Structural Panels*
- 4.1.10 *ASTM E72: Standard Test Methods of Conducting Strength Tests of Panels for Building Construction*
- 4.1.11 *ASTM E84: Standard Test Method for Surface Burning Characteristics of Building Materials*
- 4.1.12 *ASTM E90: Test Method for Laboratory Measurement of Airborne Sound Transmission Loss of Building Partitions and Elements*
- 4.1.13 *ASTM E96: Standard Test Methods for Water Vapor Transmission of Materials*
- 4.1.14 *ASTM E119: Standard Test Methods for Fire Tests of Building Construction and Materials*
- 4.1.15 *ASTM E2126: Standard Test Methods for Cyclic (Reversed) Load Test for Shear Resistance of Vertical Elements of the Lateral Force Resisting Systems for Buildings*
- 4.1.16 *ASTM E2768: Standard Test Method for Extended Duration Surface Burning Characteristics of Building Materials (30 min Tunnel Test)*
- 4.2 Structural performance for shear wall assemblies used as lateral force resisting systems in Seismic Design Categories A through F, have been tested and evaluated in accordance with the following standards:
 - 4.2.1 *ASCE/SEI 7: Minimum Design Loads and Associated Criteria for Buildings and Other Structures*
 - 4.2.2 *ASTM D7989: Standard Practice for Demonstrating Equivalent In-Plane Lateral Seismic Performance to Wood-Frame Shear Walls Sheathed with Wood Structural Panels*

- 4.2.3 *ASTM E72: Standard Test Methods of Conducting Strength Tests of Panels for Building Construction*
- 4.2.4 *ASTM E564: Standard Practice for Static Load Test for Shear Resistance of Framed Walls for Buildings*
- 4.2.5 *ASTM E2126: Standard Test Methods for Cyclic (Reversed) Load Test for Shear Resistance of Vertical Elements of the Lateral Force Resisting Systems for Buildings*
 - 4.2.5.1 ASTM D7989 is accepted engineering practice used to establish Seismic Design Coefficients (SDCs). Test data generated by ISO/IEC 17025 approved agencies and/or professional engineers, and all associated professional engineering evaluations which use ASTM D7989 as their basis, are defined as intellectual property and/or trade secrets and are also defined as an Independent Design Review (i.e., Listings, certified reports, duly authenticated reports from approved agencies, and/or research reports prepared by approved agencies and/or approved sources).

4.3 Regulations

- 4.3.1 *IBC – 15, 18, 21: International Building Code®*
- 4.3.2 *IRC – 15, 18, 21: International Residential Code®*
- 4.3.3 *IECC – 15, 18, 21: International Energy Conservation Code®*
- 4.3.4 *CBC—19, 22: California Building Code^{xx}*
- 4.3.5 *CRC—19, 22: California Residential Code^{xx}*
- 4.3.6 *CEC —19, 22: California Energy Code*
- 4.3.7 *LABC—20, 23: Los Angeles Building Code^{xxi}*
- 4.3.8 *LARC—20, 23: Los Angeles Residential Code^{xxi}*
- 4.3.9 *FBC-B—20, 23: Florida Building Code – Building^{xxii} (FL 41778)*
- 4.3.10 *FBC-R—20, 23: Florida Building Code – Residential^{xxii} (FL 41778)*
- 4.3.11 *NYSBC-B—15, 20: New York State Building Code – Building^{xxiii}*
- 4.3.12 *NYSBC-R—15, 20: New York State Building Code – Residential^{xxiii}*

5 Listed^{xxiv}

- 5.1 A nationally recognized testing laboratory such as CBI, states that the materials, designs, methods of construction and/or equipment have met nationally recognized standards and/or have been tested and found suitable for use in a specified manner.

6 Tabulated Properties Generated from Nationally Recognized Standards

6.1 Shear Wall Design

- 6.1.1 BamCore® Prime Wall™ panels may be designed as shear walls to resist lateral loads using the ASD allowable unit shear capacities for wind and seismic given in **Table 1** and **Table 2**, respectively.
- 6.1.2 The maximum aspect ratio for full-height BamCore® Prime Panel shear walls shall be 4:1. For shear walls with aspect ratios (h/b_s) greater than 2.5:1, the nominal shear capacity shall be multiplied by the Aspect Ratio Factor (WSP) = $1.25 - 0.125h/b_s$ in accordance with SDPWS Section 4.3.4.2.
- 6.1.3 The minimum aspect ratio shall be 4:1 or minimum panel width shall be 24", whichever is greater.
- 6.1.4 *Wind:*
 - 6.1.4.1 Seismic design for BamCore® Prime Wall™ panels shall not be required in buildings exempt from seismic design in accordance with IBC Section 1613.
 - 6.1.4.2 BamCore® Prime Wall™ panel shear walls that require wind design in accordance with IBC Section 1609 shall use the wind allowable unit shear capacities set forth in **Table 1**.

Table 1. Wind Allowable Unit Shear Capacity^{1,2,3,4}

Force-Resisting System	Top and Bottom Plate Material	Plate Fastener Type and Size	Half Lap Fastener Type and Size	Plate and Half Lap Fastener Spacing (in)	Hold Down	Allowable Unit Shear Capacity ¹ (plf)
BamCore® Prime Wall™ System G3 ²	2x Lumber	0.131" x 3.25" Nails	0.113" x 2" Ring Shank Nails	2 (both faces of wall)	3x Lumber ² or Post with Bucket ⁴ Hold-Down	1,460
				3 (both faces of wall)	3x Lumber ² or Post with Bucket ⁴ Hold-Down	1,190
				4 (single face of wall) ⁴	Strap ⁴ to Panel Face or Panel to Post with Bucket ⁴ Hold-Down	625

SI: 1 in = 25.4 mm, 1 lbf/ft = 0.0146 kN/m

1. BamCore® Prime Wall™ System attached in accordance with Section 2 and Section 9.
2. See **Figure 7** and **Table 3** for fastening requirements and allowable tensile load. Fastened using 0.131" x 3.25" nails on each side.
3. 4" fastener spacing only required on one panel. The other panel is allowed fastener spacing up to and including 12".
4. Hold down shall be sized to resist overturning in accordance with SDPWS Section 4.3.6

6.1.5 Seismic:

6.1.5.1 BamCore® Prime Wall™ panel shear walls that require seismic design in accordance with IBC Section 1613 shall use the seismic allowable unit shear capacities set forth in **Table 2**.

6.1.5.1.1 The response modification coefficient, R, system overstrength factor, Ω_0 , and deflection amplification factor, C_d , indicated in **Table 2**, shall be used to determine the base shear, element design forces, and design story drift in accordance with ASCE 7 Chapter 12 and Section 14.5.

6.1.5.1.2 An example of a BamCore® Prime Wall™ hold down is shown in **Figure 7**.

Table 2. Seismic Allowable Unit Shear Capacity & Seismic Design Coefficients

Seismic Force-Resisting System	Top and Bottom Plate Material	Plate Fastener	Half Lap Fastener	Plate and Half Lap Fastener Spacing (in)	Hold-Down(s)	Apparent Shear Stiffness, ³ G_a (kips/in)	Allowable Unit Shear Capacity ¹ (plf)
BamCore® Prime Wall™ System G3 ^{1,2}	2x Lumber	0.131" x 3.25" Nails	0.113" x 2" Ring Shank Nails	2 (both faces of wall)	3x Lumber ⁵ or Post with Bucket ⁶ Hold-Down	13.5	785
				3 (both faces of wall)	3x Lumber ⁵ or Post with Bucket ⁶ Hold-Down	17.5	965
				4 (single face of wall) ⁵	Strap ⁶ to Panel Face or Panel to Post with Bucket ⁶ Hold-Down	8.4	395

SI: 1 in = 25.4 mm, 1 lbf/ft = 0.0146 kN/m

1. BamCore® Prime Wall™ System attached in accordance with Section 2 and Section 9.
2. Seismic Design Coefficients
 - a. Response Modification Coefficient: $R = 6.5$
 - i. For use throughout ASCE 7
 - ii. Note: R reduces forces to a strength level, not an allowable stress level.
 - b. Overstrength Factor: $\Omega_0 = 3$
 - i. The tabulated value of the overstrength factor is permitted to be reduced by subtracting one-half (0.5) for structures with flexible diaphragms.
 - c. Deflection amplification factor: $C_d = 4$
 - i. For use with ASCE 7 Section 12.8.6, Section 12.8.7, and Section 12.9.2
 - d. Structural System Limitations & Building Height Limit: $B = NL$, $C = NL$, $D = 65$, $E = 65$, $F = 65$
 - i. $NL =$ Not Limited. Heights are measured from the base of the structure as defined in ASCE 7 Section 11.2.
3. Panel shear wall deflection shall be calculated as follows. The total vertical elongation of the wall is accounted for in the apparent shear stiffness.

$$\delta_{sw} = v h / 1000 G_a$$
 Where:
 - v = induced unit shear, lbs/ft
 - h = shear wall height, ft
 - G_a = apparent shear wall stiffness, kips/in
4. 4" fastener spacing only required on one panel. The other panel is allowed fastener spacing up to and including 12".
5. See **Figure 7** and **Table 3** for fastening requirements and allowable tensile load. Fastened using 0.131" x 3.25" nails on each side.
6. Hold-down shall be sized to resist overturning in accordance with SDPWS, Section 4.3.6. The BamCore® 3x Lumber type hold-down may be used in lieu of the Bucket Style hold-down.

6.2 Hold-Down Tensile Capacity

6.2.1 The hold-downs used in BamCore® Prime Wall™ System has the allowable wind and seismic tensile capacities shown in Table 3. See Figure 7 for additional information on the hold down assembly.

Table 3. BamCore® Hold Down Tensile Capacity^{1,2}

Product	Number of Fasteners per Side of Hold Down	3x Block Height (in)	Plate Washer Size (in)	Allowable Tensile Load, lbf (kN)	
				Wind	Seismic
BamCore® Prime Wall™ System G3	30	32	5 x 5 x 0.625	11,900 (53.0)	9,650 (42.9)
	44	46	5 x 5 x 0.625	14,600 (65.0)	7,850 (34.9)

SI: 1 in = 25.4 mm, 1 lbf = 4.45 N

1. Tested in accordance with ASTM E2126

2. BamCore® hold down installed as shown in Figure 7.

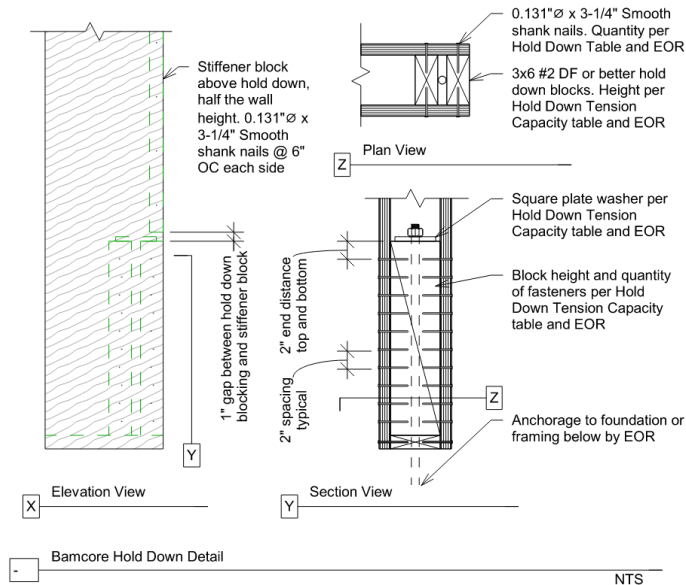

Figure 7. BamCore® Hold Down

6.3 Axial Compressive Strength

6.3.1 BamCore® Prime Wall™ System has the compressive strength shown in **Table 4**.

Table 4. Allowable Compressive Strength^{1,2}

Product	Maximum Unrestrained Wall Height, ³ (ft)	Assembly	Allowable Compressive Strength, plf (kN/m)
BamCore® Prime Wall™ System G3	10	50% 2x6 #2 DF blocking at mid height of wall spaced horizontally 8 feet on center. 0.131" diameter x 3.25" long nails at 6 inches on center	5,805 (84.7)
		70% 2x6 #2 DF blocking at mid height of wall spaced horizontally 4 feet on center. 0.131" diameter x 3.25" long nails at 4 inches on center	8,095 (118.1)
SI: 1 in = 25.4 mm, 1 lbf/ft = 0.0146 kN/m 1. Tested in accordance with ASTM E72 Section 9. 2. The minimum nominal thickness of the wall system is 8 inches. 3. Where walls span more than 10 feet, they shall have transverse restraints at the horizontal panel seams.			

6.4 BamCore® Prime Wall™ System Headers – In-Plane Bending Strength

6.4.1 On-Edge Header:

- 6.4.1.1 BamCore® Prime Wall™ panels may be designed as wall headers to carry gravity loads using the reference design values given in **Table 5**. See **Figure 8** for details of header construction.
- 6.4.1.2 Design of BamCore® Prime Wall™ headers is governed by the applicable code and the provisions for Structural Composite Lumber (SCL) in NDS.
- 6.4.1.3 Holes up to 6" in diameter are allowed in header without any reduction to **Table 5** values.
 - 6.4.1.3.1 8" minimum header depth, where hole is centered in the span and depth of the header.
- 6.4.1.4 Unless otherwise noted, adjustment of the reference design values for duration of load shall be in accordance with the applicable code.

Table 5. On-Edge Header Reference Design Values (Allowable Stress Design)^{1,2,3}

Product	Bending (Beam), ^{4,5,6} F _b psi (MPa)	Compression Parallel-to-Grain, F _c psi (MPa)	Compression Perpendicular-to-Grain, ⁷ F _{c⊥} psi (MPa)	Horizontal Shear (Beam), F _y psi (MPa)	Modulus of Rigidity (Beam), G psi (MPa)	Modulus of Elasticity (True), E psi (MPa)	Modulus of Elasticity for Beam Stability, E _{min} psi (MPa)
BamCore® Prime Wall™ System G3	2,660 (18.3)	1,580 (10.9)	1,175 (8.1)	465 (3.2)	107,000 (737)	1,340,000 (9,233)	632,000 (4,354)

SI: 1 psi = 0.00689 MPa

- The reference design values in this table are applicable for the product used in dry, well-ventilated interior applications, in which the equivalent moisture content of sawn lumber is less than nineteen percent (19%).
- The reference design values in this table are for normal load duration. Loads of other duration shall be adjusted in accordance with the applicable code. Duration of load adjustments shall not be applied to F_{c⊥} and E.
- Reference design values (except for compression parallel-to-grain) are for the BamCore® Prime Wall™ with vertical load applied along the panel edge with the strength axis (i.e., long direction of the panel) oriented parallel to the span.
- The calculated deflection of flexural members must account for combined bending and shear deflection. For uniformly loaded simple span beams, the deflection is calculated as follows:

$$\Delta = [5WL^4/(32Ebh^3)] + [63WL^2/(20Ebh)]$$
 where: Δ = deflection in inches (mm)
 W = uniform load in lb/in (N/mm)
 L = span in inches (mm)
 E = modulus of elasticity in psi (MPa)
 b = width of beam in inches (mm)
 h = depth of beam in inches (mm)
- The bending values in these tables are based on a reference depth of 12" (305 mm). For other depths, the bending value shall be adjusted by a size factor adjustment of (12/d)^{0.11} where d is measured in inches with a minimum depth of 8" (205 mm). Bending values are valid for members 1.25" in thickness and a unit volume not to exceed 2,880 in² based on the member length times the member depth.
- When structural members qualify as repetitive members in accordance with the applicable regulation, a four percent (4%) increase is permitted.
- The minimum bearing length shall be checked based on Compression Perpendicular-to-Grain. Where needed, additional bearing blocking may be added.

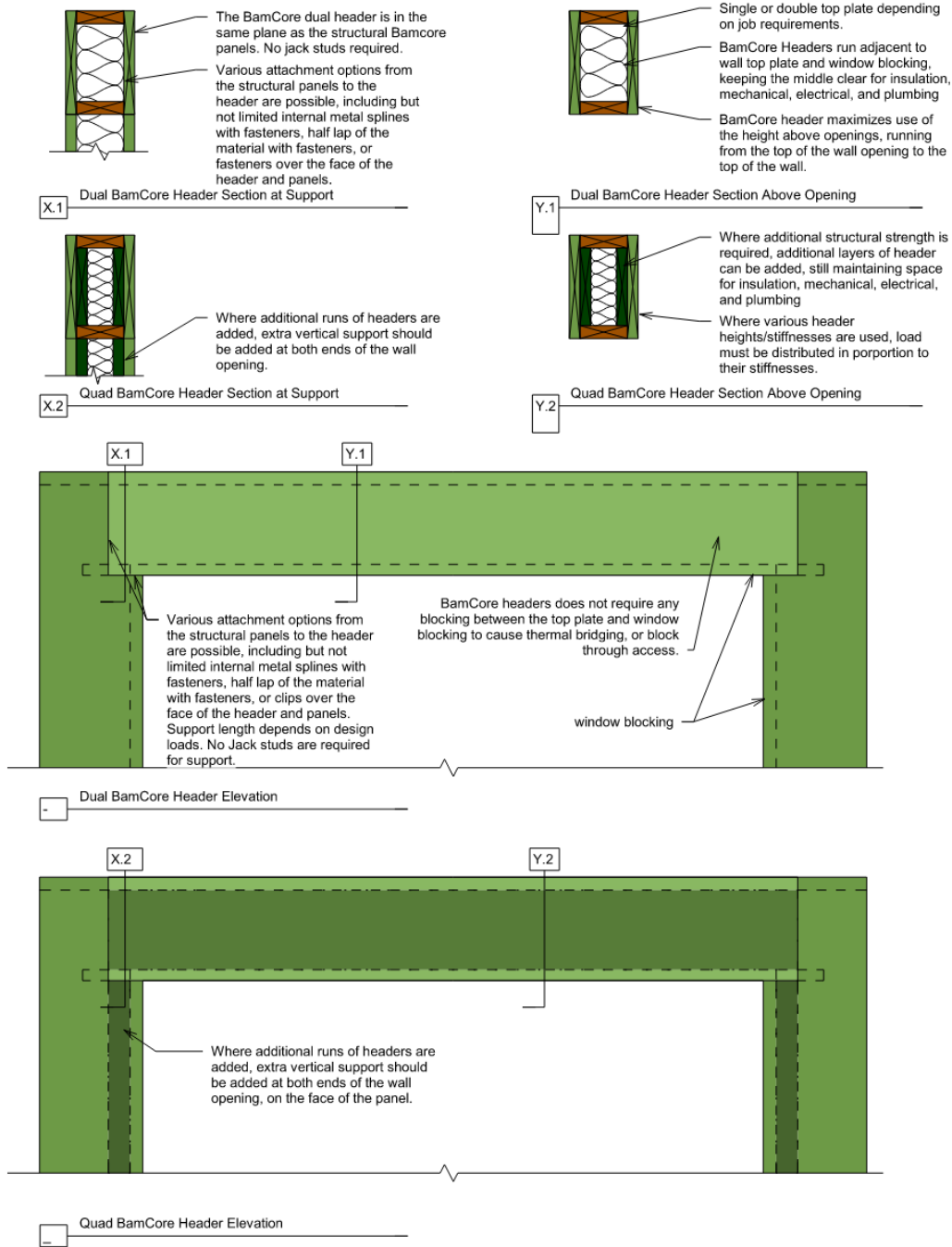

Figure 8. On-Edge Dual and Quad Header

6.4.2 **Box Beam Headers:**

- 6.4.2.1 BamCore® Prime Wall™ panels may be designed as wall headers to carry gravity loads using the reference design values given in **Table 6**. See **Figure 9** for details of header construction.
- 6.4.2.2 The design of BamCore® Prime Wall™ headers is governed by the applicable code and the provisions for Structural Composite Lumber (SCL) in NDS.
- 6.4.2.3 Holes up to 3" in diameter are allowed in header without any reduction to **Table 6** values when holes are centered in the depth of the header.
- 6.4.2.4 Unless otherwise noted, adjustment of the reference design values for duration of load shall be in accordance with the applicable code.

Table 6. BamCore® Prime Wall™ System Box Beam Header Reference Design Values (Allowable Stress Design)^{1,2,3}

Product	Max. Opening of Header (ft)	Min. Depth of Header (in)	Max. Allowable Load (lb)	Load at Deflection (lbf)		
				L/240	L/360	L/480
BamCore® Prime Wall™ System G3	4	12	7,715	6,505	4,335	3,250

SI: 1 psi = 0.00689 MPa

1. The reference design values in this table are applicable for the product used in dry, well-ventilated interior applications, in which the equivalent moisture content of sawn lumber is less than nineteen percent (19%).
2. The reference design values in this table are for normal load duration. Loads of other duration shall be adjusted in accordance with the applicable code.
3. When structural members qualify as repetitive members in accordance with the applicable code, a four percent (4%) increase is permitted.

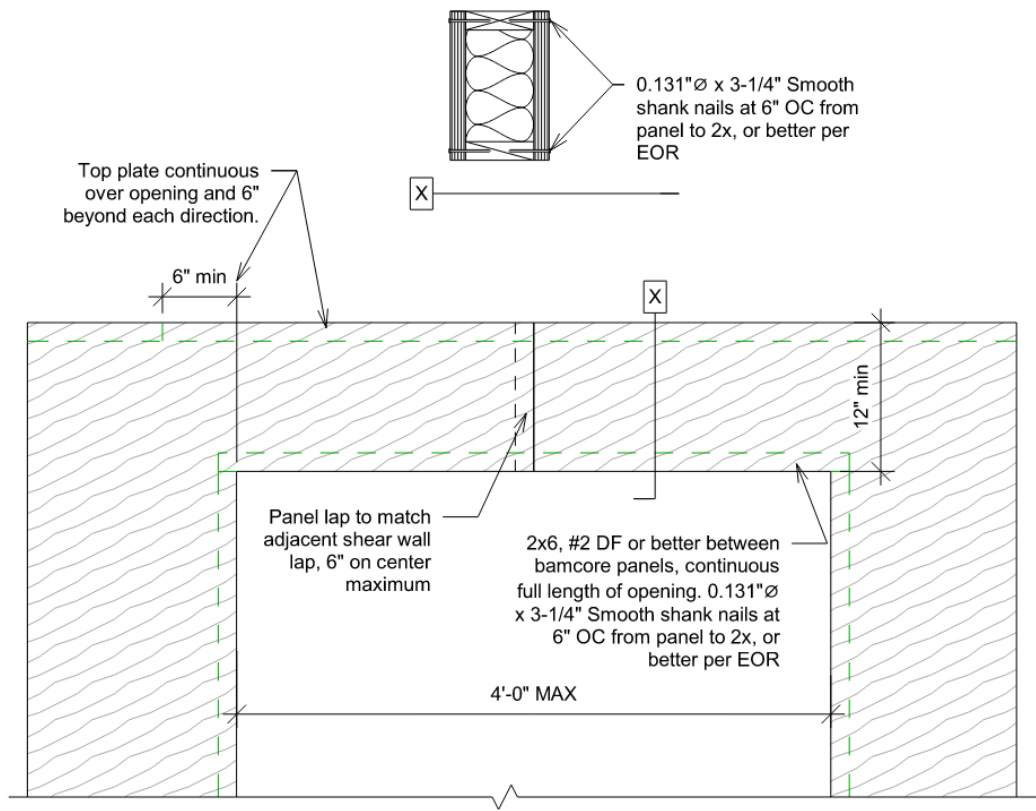

X BamCore Opening with Vertically Orientated Panel Box Beam Header (Elevation View)

Figure 9. BamCore® Opening with Vertically Orientated Panel Box Beam Header

6.5 Transverse Strength

6.5.1 BamCore® Prime Wall™ System G3 was tested and evaluated to assess the strength and deflection of the panels when subjected to transverse wind loading (see **Table 7**).

Table 7. Transverse Wind Load Performance

Product	Blocking	Finish		Wall Height, H (ft)	Allowable Transverse Load psf (kN/m) ²	Maximum Wind Speed, ⁶ V _{ult} (mph)
		Type	Deflection Limit ⁴			
BamCore® Prime Wall™ System Assembly using G3 Panels ¹	4' o.c. Blocking ²	Flexible	H/120	8	154.3 (7.4)	360
				9	108.4 (5.2)	300
				10	79.0 (3.8)	250
		Interior Walls and Partitions ⁵	H/180	8	105.5 (5.1)	300
				9	74.1 (3.5)	250
				10	54.0 (2.6)	210
		Brittle	H/240	8	80.1 (3.8)	260
				9	56.2 (2.7)	210
				10	41.0 (2)	180
		Plaster or Stucco	H/360	8	54.7 (2.6)	210
				9	38.4 (1.8)	180
				10	28.0 (1.3)	150
	8' o.c. Blocking ³	Flexible	H/120	8	107.4 (5.1)	300
				9	75.4 (3.6)	250
				10	55.0 (2.6)	210
		Interior Walls and Partitions ⁵	H/180	8	72.3 (3.5)	240
				9	50.8 (2.4)	200
				10	37.0 (1.8)	170
		Brittle	H/240	8	54.7 (2.6)	210
				9	38.4 (1.8)	180
				10	28.0 (1.3)	150
		Plaster or Stucco	H/360	8	35.2 (1.7)	170
				9	24.7 (1.2)	140
				10	18.0 (0.9)	120

SI: 1 in = 25.4 mm, 1 psf = 0.0479 kN/m², 1 mph = 1.61 km/h

1. Tested in accordance with ASTM E72 Section 12.
2. Blocking (70% of full height) installed at mid-panel at 4' o.c. and fastened with 0.131" x 3.25" nails at 4" o.c. Deflection is calculated based on 0.7 times components and cladding (ASD) loads per [IRC Table R301.7](#).
3. Blocking (50% of full height) installed at mid-panel at 8' o.c. and fastened with 0.131" x 3.25" nails at 6" o.c. Deflection is calculated based on 0.7 times components and cladding (ASD) loads per [IRC Table R301.7](#).
4. Deflection limits are from [IBC Table 1604.3](#) for exterior walls and from [IRC Table R301.7](#). H is the height of the wall panel.
5. Deflection for exterior walls with interior gypsum board finish shall be limited to an allowable deflection of H/180 per [IRC Table R301.7](#), footnote d.
6. Wind speeds based on Enclosed Building, Exposure Category B, Mean Roof Height 30', Zone 5, and 10' area.

6.6 *Surface Burning Characteristics*

6.6.1 BamCore® Prime Wall™ System panels were evaluated to assess performance with regard to flame spread and smoke developed indices as shown in **Table 8**.

Table 8. Surface Burn Characteristics^{1,2}

Product ¹	Flame Spread Index	Smoke Developed Index	Classification
Bamboo Hybrid Prime Wall™ Panels Treated with MFB-31	≤ 25	≤ 450	Class A
Bamboo Hybrid Prime Wall™ Panels	≤ 75	≤ 450	Class B
Eucalyptus Super Combi Prime Wall™ Panels	≤ 200	≤ 450	Class C

1. Tested in accordance with ASTM E84.
 2. Flame spread, and smoke developed numbers are shown for comparison purposes only and are not intended to represent the performance of BamCore® Prime Wall™ panels and related components under actual fire conditions.

6.7 *Fire-Resistance-Rated Wall Assemblies*

6.7.1 BamCore® Prime Wall™ System G3 has the fire-resistance ratings shown in **Table 9**.

Table 9. Fire-Resistance Rating¹

Product ¹	Layers of Type X Gypsum on Each Side of Assembly	Construction Requirements	Fire-Resistance Rating (min)
BamCore® Prime Wall™ System Assembly using G3 Panels	1	Section 6.7.2	60
	2	Section 6.7.3	120

1. Tested in accordance with ASTM E119

6.7.2 *One-Hour Rated Assembly:*

6.7.2.1 BamCore® Prime Wall™ System G3 assemblies were tested per ASTM E119 and have a one-hour fire resistance rating when constructed as follows:

- 6.7.2.1.1 BamCore® Prime Wall™ System G3 is assembled using a 2x lumber top and bottom plate and are fastened with 0.131" x 3.25" nails at 6" o.c. (152 mm) or less. Minimum cavity depth of 5½" (140 mm) is required.
- 6.7.2.1.2 Panel joints are constructed using 1" half lap and are fastened with 0.113" x 2" ring shank nails at 6" o.c. (152 mm) or less.
- 6.7.2.1.3 A panel stiffener (minimum 1¼" x 5½" x 5') (29 mm x 140 mm x 1,524 mm) is installed vertically at mid-height within 5' (1,524 mm) of the end of the wall and every 10' o.c. (3,048 mm) along the length of the wall. The stiffener is attached with minimum #8 x 3" (76 mm) screws.
- 6.7.2.1.4 A bead of fire sealant (3M™ Fire Barrier Sealant, three-hour or equivalent) is applied to all joints and voids in the panel surfaces.
- 6.7.2.1.5 Cellulose insulation is installed in the cavity at approximately 3 lb/ft³.
- 6.7.2.1.6 One layer of 5⁄8" (15.9 mm) Type X gypsum is installed on each face of the wall assembly with 15⁄8" (41 mm) drywall screws fastened 12" o.c. (305 mm). All joints are taped and covered with two layers of joint compound. Exposed screw heads are also covered with two coats of joint compound. Gypsum joints on one side of the wall are staggered from the joints on the opposite side by 24" (610 mm).

6.7.3 *Two-Hour Rated Assembly:*

6.7.3.1 BamCore® Prime Wall™ System G3 assemblies were tested per ASTM E119 and have a two-hour fire resistance rating when constructed as follows:

- 6.7.3.1.1 BamCore® Prime Wall™ System G3 is assembled using a 2x lumber top and bottom plate and is fastened with 0.131" x 3.25" nails at 6" o.c (152 mm) or less. Minimum cavity depth of 5 1/2" (140 mm) is required.
- 6.7.3.1.2 Panel joints are constructed using 1" half lap and are fastened with 0.113" x 2" ring shank nails at 6" o.c. (152 mm) or less.
- 6.7.3.1.3 A panel stiffener (minimum 1 1/4" x 5 1/2" x 5') (29 mm x 140 mm x 1,524 mm) is installed vertically at mid-height within 5' (1,524 mm) of the end of the wall and every 10' o.c. (3,048 mm) along the length of the wall. The stiffener is attached with minimum #8 x 3" (76 mm) screws.
- 6.7.3.1.4 A bead of fire sealant (3M™ Fire Barrier Sealant, three-hour or equivalent) is applied to all joints and voids in the panel surfaces.
- 6.7.3.1.5 Cellulose insulation is installed in the cavity at approximately 3 lb/ft³.
- 6.7.3.1.6 Two layers of 5/8" (15.9 mm) Type X gypsum are installed on each face of the wall assembly. The base layer is attached with 1 5/8" (41 mm) drywall screws fastened a maximum of 12" o.c. (305 mm). The face layer is attached with 2 1/2" (64 mm) screws at a maximum of 8" o.c. (203 mm).
- 6.7.3.1.7 All joints in the face layer are taped and covered with two layers of joint compound. Exposed screw heads are also covered with two coats of joint compound. Gypsum joints on one side of the wall are staggered from the joints on the opposite side by 24" (610 mm).

6.8 *Vapor Transmission*

6.8.1 The BamCore® Prime Wall™ System G3 panel has the water vapor transmission values and corresponding vapor retarder class shown in **Table 10**.

Table 10. Vapor Transmission

Product	Interior Surface Finish	Permeance Desiccant Method ¹ (perms) (g/ft ² *h*in Hg)	Permeance Water Method ² (perms) (g/ft ² *h*in Hg)	Vapor Retarder Class
BamCore® Prime Wall™ System Assembly using G3 Panels	MDO	0.21	2.15	Class I
	Bare Panel	0.44	2.90	Class II

1. Tested in accordance with ASTM E96 Procedure A
 2. Tested in accordance with ASTM E96 Procedure B

6.8.2 Use as a vapor retarder is the responsibility of the building designer and shall be designed in accordance with IBC Section 1404.3.^{xxv}

6.9 Sound Transmission

6.9.1 BamCore® Prime Wall™ System G3 has the sound transmission ratings shown in **Table 11**.

Table 11. Sound Transmission Ratings^{1,2}

Product	Blocking and Insulation	Exterior GWB ²	Interior GWB ²	Sound Transmission Class (STC)
BamCore® Prime Wall™ System G3	2x6 top/bottom plates w/two (2) 70% height blocks and blown-in insulation	Single layer of 5/8" Type X GWB	Single layer of 5/8" Type X GWB	45
			Single layer of 5/8" CertainTeed SilentFX	47
		Two layers of 5/8" Type X GWB	Two layers of 5/8" Type X GWB	48
			Single layer of 5/8" CertainTeed SilentFX or QuietRock ES GWB and Single layer of 5/8" Type X GWB	50
	2x6 top plate with split bottom plate and two (2) 70% height blocks and blown-in insulation	Single layer of 5/8" Type X GWB	Single layer of 5/8" Type X GWB	46
	2x6 top/bottom plates w/one (1) 50% height block off-center and blown-in insulation	Single layer of 5/8" Type X GWB	Single layer of 5/8" Type X GWB	50
			Single layer of 5/8" CertainTeed SilentFX or QuietRock ES GWB	52
		Two layers of 5/8" Type X GWB	Two layers of 5/8" Type X GWB	53

1. Tested in accordance with ASTM E90.
2. GWB screws are fastened directly into the BamCore® panel. The first GWB layer has 8":12" (edge:field) fastener spacing. Where applicable, the second GWB layer has 8":8" (edge:field) fastener spacing.

6.10 Thermal Resistance (R-Value)

6.10.1 BamCore® Prime Wall™ System has the thermal resistance shown in **Table 12** and **Table 13**.

Table 12. BamCore® Prime Wall™ System R-Values and U-Factors – Tested

Product or Assembly	R-Value [(°F·ft ² ·h)/Btu]	U-Factor [Btu/(°F·ft ² ·h)]	
		0°F to 70°F	50°F to 100°F
BamCore® Prime Wall™ Panel ¹ (Single 1.25" Thick Panel)	1.6	0.625	
BamCore® Prime Wall™ System with Single Layer 5/8" (15.9 mm) Type X on One Side ²	20.3	0.037	0.047
BamCore® Prime Wall™ System with Single Layer 5/8" (15.9 mm) Type X on Both Sides ³	22.3	N/A	0.043

1. Thermal values are determined using the ASTM C518 test method at 75°F mean temperature and 50°F temperature differential.
 2. Thermal values are determined using the ASTM C1363 test method at 75°F mean temperature and 50°F temperature differential.
 a. Cavity of wall filled with 5 1/2" (140 mm) dry cellulose blown-in insulation at 3.5 lb. density.
 b. Seams of BamCore® Prime Wall™ panels and gypsum filled with silicone caulking.
 c. Framing factor of 6.65% (representative of an exterior wall configuration)
 3. Thermal values are determined using the ASTM C1363 test method at 75°F mean temperature and 50°F temperature differential.
 a. Cavity of wall filled with 5 1/2" (140 mm) dry cellulose blown-in insulation at 3.5 lb. density.
 b. Seams of BamCore® Prime Wall™ panels and gypsum filled with silicone caulking.
 c. Framing factor of 3.91% (representative of a common wall configuration)

Table 13. BamCore® Prime Wall™ System R-Values and U-Factors – Calculated¹

Product Assembly	R-Value [(°F·ft ² ·h)/Btu]	U-Factor [Btu/(°F·ft ² ·h)]
BamCore® Prime Wall™ System ² with Cellulose Insulation ³	22.1	0.045
BamCore® Prime Wall™ System ² with Fiberglass Insulation ⁴	24.7	0.040

1. Thermal values calculated in accordance with the California Energy Code (CEC).
 2. Assembly with 6.65% framing factor:
 a. Air Film: outside air film
 b. Siding: 3/8" 2-coat stucco
 c. Sheathing Insulation: none
 d. Building Paper: felt
 e. Structural Panel: 1 1/4" BamCore® Panel
 f. Framing: 2x6 DF
 g. Structural Panel: 1 1/4" BamCore® Panel
 h. Interior Finish: 1/2" gypsum board
 i. Air Film: Inside air film
 3. Cavity insulation: R3.5 per inch Dense Pack Cellulose.
 4. Cavity insulation: R4.1 per inch Fiberglass.

6.11 Where the application falls outside of the performance evaluation, conditions of use and/or installation requirements set forth herein, alternative techniques shall be permitted in accordance with accepted engineering practice and experience. This includes but is not limited to the following areas of engineering: mechanics or materials, structural, building science, and fire science.

7 Certified Performance^{xxvi}

- 7.1 All construction methods shall conform to accepted engineering practices to ensure durable, livable, and safe construction and shall demonstrate acceptable workmanship reflecting journeyman quality of work of the various trades.^{xxvii}
- 7.2 The strength and rigidity of the component parts and/or the integrated structure shall be determined by engineering analysis or by suitable load tests to simulate the actual loads and conditions of application that occur.^{xxviii}

8 Regulatory Evaluation and Accepted Engineering Practice

- 8.1 BamCore® Prime Wall™ System complies with the following legislatively adopted regulations and/or accepted engineering practice for the following reasons:
 - 8.1.1 Lateral force resisting systems for use in both wind and seismic applications follow the performance-based provisions of IBC Section 2306.1, IBC Section 2306.3, and/or Section 4.3 SDPWS for light-frame wood wall assemblies.
 - 8.1.1.1 **Table 2** provides SDCs that conform to the requirements in ASCE 7 Section 12.2.1, 12.2.1.1 and Table 12.2-1 for design of wall assemblies in buildings that require seismic design.
 - 8.1.2 Structural performance for shear wall assemblies used as lateral force resisting systems in Seismic Design Categories A through F, have been tested and evaluated in accordance with the following standards:
 - 8.1.2.1 ASCE/SEI 7: Minimum Design Loads and Associated Criteria for Buildings and Other Structures
 - 8.1.2.2 ASTM D7989: Standard Practice for Demonstrating Equivalent In-Plane Lateral Seismic Performance to Wood-Frame Shear Walls Sheathed with Wood Structural Panels
 - 8.1.2.2.1 ASTM D7989 is accepted engineering practice used to establish SDCs. Test data generated by ISO/IEC 17025 approved agencies and/or professional engineers, and all associated professional engineering evaluations, which use ASTM D7989 as their basis, are defined as intellectual property and/or trade secrets and are also defined as an independent design review (i.e., Listings, certified reports, duly authenticated reports from approved agencies, and/or research reports prepared by approved agencies and/or approved sources).
 - 8.1.2.3 ASTM E2126: Standard Test Methods for Cyclic (Reversed) Load Test for Shear Resistance of Vertical Elements of the Lateral Force Resisting Systems for Buildings
 - 8.1.2.4 **Table 1** provides wind allowable shear capacity in accordance with IBC Section 1609.
 - 8.1.2.5 **Table 2** provides allowable shear capacity and seismic design coefficients (SDCs) that conform to the requirements in ASCE 7 Section 12.2.1, 12.2.1.1, and Table 12.2-1 for design of wall assemblies in buildings that require seismic design per IBC Section 1613.
 - 8.1.3 Compressive strength in accordance with ASTM E72 and ASTM D198.
 - 8.1.4 In-plane bending strength for use as headers in accordance with ASTM E72 and ASTM D198.
 - 8.1.5 Performance under transverse (out-of-plane) load conditions in accordance with IBC Section 1609.1.1 and IRC Section R301.2.1.
 - 8.1.6 Flame spread index and smoke developed index properties as required by IBC Section 2303.2, IRC Section R302.9 and IRC Section R802.1.5 when applicable.
 - 8.1.7 Performance in fire-resistance-rated wall assemblies in accordance with IBC Section 2603.5.1.
 - 8.1.8 Water vapor transmission performance in accordance with IBC Section 1404.3^{xxix} and IRC Section R702.7.
 - 8.1.9 Sound transmission rating performance in accordance with IBC Section 1206 and IRC Appendix AK.
 - 8.1.10 Thermal performance in accordance with IECC Section C402.1.

- 8.2 Any building code, regulation and/or accepted engineering evaluations (i.e., research reports, duly authenticated reports, etc.) that are conducted for this Listing were performed by DrJ Engineering, LLC (DrJ), an ISO/IEC 17065 accredited certification body and a professional engineering company operated by RDP/approved sources. DrJ is qualified^{xxx} to practice product and regulatory compliance services within its scope of accreditation and engineering expertise, respectively.
- 8.3 Engineering evaluations are conducted with DrJ's ANAB accredited ICS code scope of expertise, which are also its areas of professional engineering competence.
- 8.4 Any regulation specific issues not addressed in this section are outside the scope of this report.

9 Installation

- 9.1 Installation shall comply with the approved construction documents, the manufacturer installation instructions, this TER, and the applicable building code.
- 9.2 In the event of a conflict between the manufacturer installation instructions and this report, the more restrictive shall govern.
- 9.3 The BamCore® Prime Wall™ panels must be stored and handled to protect panels from damage in storage, during shipment, and on the job site.
 - 9.3.1 If panels must be stored outside, stack them on a level platform supported by at least three 4x4s to keep them off the ground. Place one 4x4 in the center and the other two 12" (305 mm) to 16" (406 mm) from the ends. Never leave the platform in direct contact with the ground.
 - 9.3.2 Cover the stack loosely with plastic sheets or tarps. Anchor the covering at the top of the stack, but keep it open and away from the sides and bottom to ensure good ventilation. Tight coverings prevent air circulation and when exposed to sunlight, may promote mold or mildew.
 - 9.3.3 Please refer to the APA Technical Note E705, "Proper Storage and Handling of I-Joists and LVL" and the APA Builder Tips U450, "Storage and Handling of APA Trademarked Panels" for additional recommendations.
- 9.4 BamCore® Prime Wall™ System shall be designed for dry use and shall be adequately protected from moisture and pests.
- 9.5 BamCore® Prime Wall™ System shall be installed in accordance with the approved construction documents, the installation instructions provided with the shipment of panels, and this TER. In the event of a conflict between the manufacturer installation instructions, approved construction documents by an RDP, and this report, the more restrictive shall govern.
 - 9.5.1 Generic details provided by BamCore® shall be evaluated and revised by an RDP for applicability to a specific building.
 - 9.5.2 Support for BamCore® Prime Wall™ System (i.e., foundation walls, footings) shall be designed by an RDP.
- 9.6 Support for BamCore® Prime Wall™ Panels must be flat, level, free of debris and match the dimensions provided by an RDP.
- 9.7 BamCore® Prime Wall™ Panels are installed and aligned in accordance with the plans designed and submitted to the building official per Section 9.
- 9.8 All panels are stamped with sequencing identification to correspond to the approved construction documents for easy placement in the correct location.
- 9.9 *Installation Procedure*
 - 9.9.1 Layout the bottom plate/track as shown on the approved construction documents. Attach to the structure above and below per approved construction documents.
 - 9.9.2 Install panels for the exterior side of the wall starting at a corner.
 - 9.9.3 Place adjoining panels per the numbered sequencing on the approved construction documents by placing each panel on/next to the plate. Fasten per Section 2.3.3 and approved construction documents. Continue until all exterior panels are set.

- 9.9.4 Repeat the steps above for the panels on the interior side of the exterior walls. Refer to approved construction documents to determine placement of additional blocking for deflection criteria to be met.
- 9.9.5 Add panel blocking around each window and door to connect the panels on the interior and exterior sides of the exterior walls together.
- 9.9.6 The top plate can either be set on blocking or clamped in place while fastening it to the panel. Fasten per Section 2.3.3 and approved construction documents.
- 9.9.7 Interior load bearing walls are installed in the same manner.
- 9.9.8 For more details on the installation of BamCore® Prime Wall™ System assemblies and subsequent installation of other trades within the assemblies, see bamcore.com.

10 Substantiating Data

- 10.1 Testing has been performed under the supervision of a professional engineer and/or under the requirements of ISO/IEC 17025 as follows:
 - 10.1.1 Shear wall performance in accordance with ASTM E2126
 - 10.1.2 Axial and transverse load performance in accordance with ASTM E72 Section 9 and Section 11
 - 10.1.3 Use as headers in accordance with ASTM D198
 - 10.1.4 Comparative testing on Eucalyptus Super Combi Prime Wall™ panels in accordance with ASTM D198
 - 10.1.5 Flame spread and smoke density in accordance with ASTM E84 and ASTM E2768
 - 10.1.6 Fire-resistant assembly rating in accordance with ASTM E119
 - 10.1.7 Water vapor transmission in accordance with ASTM E96
 - 10.1.8 Sound transmission in accordance with ASTM E90
 - 10.1.9 Thermal properties in accordance with ASTM C518 and ASTM C1363
- 10.2 Information contained herein may include the result of testing and/or data analysis by sources that are [approved agencies](#), [approved sources](#) and/or [RDPs](#). Accuracy of external test data and resulting analysis is relied upon.
- 10.3 Where pertinent, testing and/or engineering analysis are based upon provisions that have been codified into law through state or local adoption of regulations and standards. The developers of these regulations and standards are responsible for the reliability of published content. DrJ's engineering practice may use a regulation-adopted provision as the control. A regulation-endorsed control versus a simulation of the conditions of application to occur establishes a new material as [being equivalent](#) to the regulatory provision in terms of quality, [strength](#), effectiveness, [fire resistance](#), durability, and safety.
- 10.4 The accuracy of the provisions provided herein may be reliant upon the published properties of raw materials, which are defined by the grade mark, grade stamp, mill certificate, or [duly authenticated reports](#) from [approved agencies](#) and/or [approved sources](#) provided by the supplier. These are presumed to be minimum properties and relied upon to be accurate. The reliability of DrJ's engineering practice, as contained in this [duly authenticated report](#), may be dependent upon published design properties by others.
- 10.5 Testing and engineering analysis: The strength, rigidity and/or general performance of component parts and/or the integrated structure are determined by suitable tests that simulate the actual conditions of application that occur and/or by accepted engineering practice and experience.^{xxxi}
- 10.6 Where additional condition of use and/or regulatory compliance information is required, please search for BamCore® Prime Wall™ System on the [DrJ Certification](#) website.

11 Findings

- 11.1 As outlined in Section 6, BamCore® Prime Wall™ System has performance characteristics that were tested and/or meet applicable regulations and is suitable for use pursuant to its specified purpose.
- 11.2 When used and installed in accordance with this duly authenticated report and the manufacturer installation instructions, BamCore® Prime Wall™ System shall be approved for the following applications:
- 11.2.1 Use as a wall system.
- 11.3 Unless exempt by state statute, when BamCore® Prime Wall™ System is to be used as a structural and/or building envelope component in the design of a specific building, the design shall be performed by an RDP.
- 11.4 Any application specific issues not addressed herein can be engineered by an RDP. Assistance with engineering is available from Global Bamboo Technologies Inc.
- 11.5 IBC Section 104.11 (IRC Section R104.11 and IFC Section 104.10^{xxxii} are similar) in pertinent part states:
- 104.11 Alternative materials, design and methods of construction and equipment.** The provisions of this code are not intended to prevent the installation of any material or to prohibit any design or method of construction not specifically prescribed by this code. Where the alternative material, design or method of construction is not approved, the building official shall respond in writing, stating the reasons the alternative was not approved.
- 11.6 **Approved:**^{xxxiii} Building regulations require that the building official shall accept duly authenticated reports.^{xxxiv}
- 11.6.1 An approved agency is “approved” when it is ANAB ISO/IEC 17065 accredited.
- 11.6.2 An approved source is “approved” when an RDP is properly licensed to transact engineering commerce.
- 11.6.3 Federal law, Title 18 US Code Section 242, requires that where the alternative product, material, service, design, assembly, and/or method of construction is not approved, the building official shall respond in writing, stating the reasons why the alternative was not approved. Denial without written reason deprives a protected right to free and fair competition in the marketplace.
- 11.7 DrJ is a licensed engineering company, employs licensed RDPs and is an ANAB-Accredited Product Certification Body – Accreditation #1131.
- 11.8 Through the IAF Multilateral Agreements (MLA), this Duly Authenticated Report can be used to obtain product approval in any jurisdiction or country because all ANAB ISO/IEC 17065 Duly Authenticated Reports are equivalent.^{xxxv}

12 Conditions of Use

- 12.1 Material properties shall not fall outside the boundaries defined in Section 6.
- 12.2 As defined in Section 6, where material and/or engineering mechanics properties are created for load resisting design purposes, the resistance to the applied load shall not exceed the ability of the defined properties to resist those loads using the principles of accepted engineering practice.
- 12.3 As listed herein, BamCore® Prime Wall™ System shall not be used:
- 12.3.1 If cut or notched except where specifically permitted by the manufacturer recommendations or where the effects of such alterations are specifically considered in the design of the member by a registered design professional.
- 12.4 BamCore® Prime Wall™ System must be designed, manufactured, labelled, and installed in accordance with this report and the applicable building code.
- 12.5 All connections shall be in accordance with this report, approved construction documents (by an RDP), and the applicable building code, based on individual job requirements.
- 12.6 Design calculations and details shall be furnished to the code official verifying that the material is used in compliance with this report. The calculations must be prepared by an RDP where required by the statutes of the jurisdiction in which the project is to be constructed.

- 12.7 The design values shall not exceed those set forth in this report as modified by all applicable table notes.
- 12.8 The service conditions for BamCore® Prime Wall™ System with fire-retardant treatments are outside the scope of this report.
- 12.9 No increases for duration of load are permitted.
- 12.10 When required by adopted legislation and enforced by the building official, also known as the authority having jurisdiction (AHJ) in which the project is to be constructed:
- 12.10.1 Any calculations incorporated into the construction documents shall conform to accepted engineering practice and, when prepared by an approved source, shall be approved when signed and sealed.
- 12.10.2 This report and the installation instructions shall be submitted at the time of permit application.
- 12.10.3 This innovative product has an internal quality control program and a third-party quality assurance program.
- 12.10.4 At a minimum, this innovative product shall be installed per Section 9 of this report.
- 12.10.5 The review of this report by the AHJ shall comply with IBC Section 104 and IBC Section 105.4.
- 12.10.6 This innovative product has an internal quality control program and a third party quality assurance program in accordance with IBC Section 104.4, IBC Section 110.4, IBC Section 1703, IRC Section R104.4 and IRC Section R109.2.
- 12.10.7 The application of this innovative product in the context of this report is dependent upon the accuracy of the construction documents, implementation of installation instructions, inspection as required by IBC Section 110.3, IRC Section R109.2 and any other regulatory requirements that may apply.
- 12.11 The approval of this report by the AHJ shall comply with IBC Section 1707.1, where legislation states in part, *"the building official shall accept duly authenticated reports from approved agencies in respect to the quality and manner of use of new material or assemblies as provided for in Section 104.11", all of IBC Section 104, and IBC Section 105.4.*
- 12.12 Design loads shall be determined in accordance with the regulations adopted by the jurisdiction in which the project is to be constructed and/or by the building designer (i.e., owner or RDP).
- 12.13 The actual design, suitability, and use of this report, for any particular building, is the responsibility of the owner or the authorized agent of the owner.

13 Identification

- 13.1 The innovative product listed in Section 1.1 is identified by a label on the board or packaging material bearing the manufacturer name, product name, this report number, and other information to confirm code compliance.
- 13.2 Additional technical information can be found at bamcore.com.

14 Review Schedule

- 14.1 This report is subject to periodic review and revision. For the latest version, visit drjcertification.org.
- 14.2 For information on the status of this report, please contact DrJ Certification.

15 Approved for Use Pursuant to U.S. and International Legislation Defined in Appendix A

- 15.1 BamCore® Prime Wall™ System is included in this report published by an approved agency that is concerned with evaluation of products or services, maintains periodic inspection of the production of listed materials or periodic evaluation of services. This report states either that the material, product, or service meets recognized standards or has been tested and found suitable for a specified purpose. This report meets the legislative intent and definition of being acceptable to the AHJ.

Appendix A

1 Legislation that Authorizes AHJ Approval

- 1.1 **Fair Competition:** State legislatures have adopted Federal regulations for the examination and approval of building code referenced and alternative products, materials, designs, services, assemblies and/or methods of construction that:
- 1.1.1 Advance Innovation,
 - 1.1.2 Promote competition so all businesses have the opportunity to compete on price and quality in an open market on a level playing field unhampered by anticompetitive constraints, and
 - 1.1.3 Benefit consumers through lower prices, better quality, and greater choice.
- 1.2 **Adopted Legislation:** The following local, state, and federal regulations affirmatively authorize this innovative product to be approved by AHJs, delegates of building departments, and/or delegates of an agency of the federal government:
- 1.2.1 Interstate commerce is governed by the Federal Department of Justice to encourage the use of innovative products, materials, designs, services, assemblies and/or methods of construction. The goal is to “protect economic freedom and opportunity by promoting free and fair competition in the marketplace.”
 - 1.2.2 Title 18 US Code Section 242 affirms and regulates the right of individuals and businesses to freely and fairly have new products, materials, designs, services, assemblies and/or methods of construction approved for use in commerce. Disapproval of alternatives shall be based upon non-conformance with respect to specific provisions of adopted legislation, and shall be provided in writing stating the reasons why the alternative was not approved, with reference to the specific legislation violated.
 - 1.2.3 The federal government and each state have a public records act. In addition, each state also has legislation that mimics the federal Defend Trade Secrets Act 2016 (DTSA),^{xxxvi} where providing test reports, engineering analysis and/or other related IP/TS is subject to prison of not more than ten years^{xxxvii} and/or a \$5,000,000 fine or 3 times the value of^{xxxviii} the Intellectual Property (IP) and Trade Secrets (TS).
 - 1.2.3.1 Compliance with public records and trade secret legislation requires approval through the use of Listings, certified reports, Technical Evaluation Reports, duly authenticated reports and/or research reports prepared by approved agencies and/or approved sources.
 - 1.2.4 For new materials^{xxxix} that are not specifically provided for in any regulation, the design strengths and permissible stresses shall be established by tests, where suitable load tests simulate the actual loads and conditions of application that occur.
 - 1.2.5 The design strengths and permissible stresses of any structural material shall conform to the specifications and methods of design using accepted engineering practice.^{xl}
 - 1.2.6 The commerce of approved sources (i.e., registered PEs) is regulated by professional engineering legislation. Professional engineering commerce shall always be approved by AHJs, except where there is evidence provided in writing, that specific legislation has been violated by an individual registered PE.
 - 1.2.7 The AHJ shall accept duly authenticated reports from approved agencies in respect to the quality and manner of use of new materials or assemblies as provided for in IBC Section 104.11.^{xli}

- 1.3 **Approved^{xliii} by Los Angeles:** The Los Angeles Municipal Code (LAMC) states in pertinent part that the provisions of LAMC are not intended to prevent the use of any material, device, or method of construction not specifically prescribed by LAMC. The Department shall use Part III, Recognized Standards in addition to Part II, Uniform Building Code Standards of Division 35, Article 1, Chapter IX of the LAMC in evaluation of products for approval where such standard exists for the product or the material and may use other approved standards that apply. Whenever tests or certificates of any material or fabricated assembly are required by Chapter IX of the LAMC, such tests or certification shall be made by a testing agency approved by the Superintendent of Building to conduct such tests or provide such certifications. The testing agency shall publish the scope and limitation(s) of the listed material or fabricated assembly.^{xliii} The Superintendent of Building Approved Testing Agency Roster is provided by the Los Angeles Department of Building and Safety (LADBS). The Center for Building Innovation (CBI) Certificate of Approval License is TA24945. Tests and certifications found in a DrJ Listing are LAMC approved. In addition, the Superintendent of Building shall accept duly authenticated reports from approved agencies in respect to the quality and manner of use of new materials or assemblies as provided for in the California Building Code (CBC) Section 1707.1.^{xliiv}
- 1.4 **Approved by Chicago:** The Municipal Code of Chicago (MCC) states in pertinent part that an Approved Agency is a Nationally Recognized Testing Laboratory (NRTL) acting within its recognized scope and/or a certification body accredited by the American National Standards Institute (ANSI) acting within its accredited scope. Construction materials and test procedures shall conform to the applicable standards listed in the MCC. Sufficient technical data shall be submitted to the building official to substantiate the proposed use of any product, material, service, design, assembly and/or method of construction not specifically provided for in the MCC. This technical data shall consist of research reports from approved sources (i.e., MCC defined Approved Agencies).
- 1.5 **Approved by New York City:** The 2022 NYC Building Code (NYCBC) states in part that an approved agency shall be deemed^{xliv} an approved testing agency via ISO/IEC 17025 accreditation, an approved inspection agency via ISO/IEC 17020 accreditation, and an approved product evaluation agency via ISO/IEC 17065 accreditation. Accrediting agencies, other than federal agencies, must be members of an internationally recognized cooperation of laboratory and inspection accreditation bodies subject to a mutual recognition agreement^{xlvi} (i.e., ANAB, International Accreditation Forum (IAF), etc.).
- 1.6 **Approved by Florida:** Statewide approval of products, methods, or systems of construction shall be approved, without further evaluation by:
- 1.6.1 A certification mark or listing of an approved certification agency,
 - 1.6.2 A test report from an approved testing laboratory,
 - 1.6.3 A product evaluation report based upon testing or comparative or rational analysis, or a combination thereof, from an approved product evaluation entity, or
 - 1.6.4 A product evaluation report based upon testing, comparative or rational analysis, or a combination thereof, developed, signed and sealed by a professional engineer or architect, licensed in Florida.
- 1.7 For local product approval, products or systems of construction shall demonstrate compliance with the structural wind load requirements of the Florida Building Code (FBC) through one of the following methods;
- 1.7.1 A certification mark, listing or label from a commission-approved certification agency indicating that the product complies with the code,
 - 1.7.2 A test report from a commission-approved testing laboratory indicating that the product tested complies with the code,
 - 1.7.3 A product-evaluation report based upon testing, comparative or rational analysis, or a combination thereof, from a commission-approved product evaluation entity which indicates that the product evaluated complies with the code,
 - 1.7.4 A product-evaluation report or certification based upon testing or comparative or rational analysis, or a combination thereof, developed and signed and sealed by a Florida professional engineer or Florida registered architect, which indicates that the product complies with the code, or
 - 1.7.5 A statewide product approval issued by the Florida Building Commission.

- 1.8 The [Florida Department of Business and Professional Regulation \(DBPR\)](#) website provides a listing of companies certified as a [Product Evaluation Agency](#) (i.e., EVLMiami 13692), a [Product Certification Agency](#) (i.e., CER10642), and as a [Florida Registered Engineer](#) (i.e., ANE13741).
- 1.9 **Approved by Miami-Dade County (i.e., Notice of Acceptance [NOA]):** A Florida statewide approval is an NOA. An NOA is a Florida local product approval. By Florida law, Miami-Dade County shall accept the statewide and local Florida Product Approval as provided for in Florida legislation [553.842](#) and [553.8425](#).
- 1.10 **Approved by New Jersey:** Pursuant to the 2018 Building Code of New Jersey in [IBC Section 1707.1 General](#),^{xlvii} it states: *“In the absence of approved rules or other approved standards, the building official shall accept duly authenticated reports from [approved agencies](#) in respect to the quality and manner of use of new materials or assemblies as provided for in the administrative provisions of the Uniform Construction Code (N.J.A.C. 5:23)”*.^{xlviii} Furthermore N.J.A.C 5:23-3.7 states: *“Municipal approvals of alternative materials, equipment, or methods of construction.”*
 - 1.10.1 **Approvals:** Alternative materials, equipment, or methods of construction shall be approved by the appropriate subcode official provided the proposed design is satisfactory and that the materials, equipment, or methods of construction are suitable for the intended use and are at least the equivalent in quality, strength, effectiveness, fire resistance, durability and safety of those conforming with the requirements of the regulations.
 - 1.10.1.1 A field evaluation label and report or letter issued by a nationally recognized testing laboratory verifying that the specific material, equipment, or method of construction meets the identified standards or has been tested and found to be suitable for the intended use, shall be accepted by the appropriate subcode official as meeting the requirements of the above.
 - 1.10.1.2 Reports of engineering findings issued by nationally recognized evaluation service programs such as but not limited to, the Building Officials and Code Administrators (BOCA), the International Conference of Building Officials (ICBO), the Southern Building Code Congress International (SBCCI), the International Code Council (ICC) and the National Evaluation Service, Inc., shall be accepted by the appropriate subcode official as meeting the requirements of the above.
 - 1.10.2 The [New Jersey Department of Community Affairs](#) has confirmed that technical evaluation reports, from any accredited entity listed by [ANAB](#), meets the requirements of item the previous paragraph, given that the listed entities are no longer in existence and/or do not provide *“reports of engineering findings”*.
- 1.11 **Approved by the Code of Federal Regulations Manufactured Home Construction and Safety Standards:** Pursuant to Title 24, Subtitle B, Chapter XX, [Part 3282.14](#)^{xlix} and [Part 3280](#),^l the Department encourages innovation and the use of new technology in manufactured homes. The design and construction of a manufactured home shall conform to the provisions of Part 3282 and Part 3280 where key approval provisions in mandatory language follow:
 - 1.11.1 *“All construction methods shall be in conformance with accepted engineering practices”*
 - 1.11.2 *“The strength and rigidity of the component parts and/or the integrated structure shall be determined by engineering analysis or by suitable load tests to simulate the actual loads and conditions of application that occur.”*
 - 1.11.3 *“The design stresses of all materials shall conform to accepted engineering practice.”*

- 1.12 **Approval by US, Local, and State Jurisdictions in General:** In all other local and state jurisdictions, the adopted building code legislation states in pertinent part that:
- 1.12.1 For new materials that are not specifically provided for in this code, the design strengths and permissible stresses shall be established by tests.ⁱⁱ
 - 1.12.2 For innovative alternatives, and/or methods of construction, the building official shall accept duly authenticated reports from approved agencies with respect to the quality and manner of use of new materials or assemblies.ⁱⁱⁱ
 - 1.12.2.1 An approved agency is “approved” when it is ANAB ISO/IEC 17065 accredited. DrJ Engineering, LLC (DrJ) is in the ANAB directory.
 - 1.12.2.2 An approved source is “approved” when an RDP is properly licensed to transact engineering commerce. The regulatory authority governing approved sources is the state legislature via its professional engineering regulations.^{liii}
 - 1.12.3 The design strengths and permissible stresses of any structural material...shall conform to the specifications and methods of design of accepted engineering practice performed by an approved source.^{liv}
- 1.13 **Approval by International Jurisdictions:** The USMCA and GATT agreements provide for approval of innovative materials, designs, services, and/or methods of construction through the Agreement on Technical Barriers to Trade and the IAF Multilateral Recognition Arrangement (MLA), where these agreements:
- 1.13.1 State that conformity assessment procedures (i.e., ISO/IEC 17020, 17025, 17065, etc.) are prepared, adopted, and applied so as to grant access for suppliers of like products originating in the territories of other Members under conditions no less favourable than those accorded to suppliers of like products of national origin or originating in any other country, in a comparable situation.
 - 1.13.2 **Approved:** The purpose of the MLA is to ensure mutual recognition of accredited certification and validation/verification statements between signatories to the MLA, and subsequently acceptance of accredited certification and validation/verification statements in many markets based on one accreditation for the timely approval of innovative materials, designs, services, and/or methods of construction.
 - 1.13.3 ANAB is an IAF-MLA signatory where recognition of certificates, validation and verification statements issued by conformity assessment bodies accredited by all other signatories of the IAF MLA, with the appropriate scope, shall be approved.^{lv}
 - 1.13.4 Therefore, all ANAB ISO/IEC 17065 Duly Authenticated Reports are approval equivalent.^{lvi}
- 1.14 Approval equity is a fundamental commercial and legal principle.^{lvii}

California Supplement to Report Number 1507-03

REPORT HOLDER: Global Bamboo Technologies Inc.

1 Evaluation Subject

- 1.1 BamCore® Prime Wall™ System

2 Purpose and Scope

2.1 Purpose

- 2.1.1 The purpose of this Report supplement is to show BamCore® Prime Wall™ System, recognized in this report, has also been evaluated for compliance with the codes listed below.

2.2 *Applicable Code Editions*

- 2.2.1 *CBC—16, 19: California Building Code (Title 24, Part 2)*
- 2.2.2 *CRC—16, 19: California Residential Code (Title 24, Part 2.5)*
- 2.2.3 *CEC —16, 19: California Energy Code (Title 24, Part 6)*

3 Conclusions

- 3.1 BamCore® Prime Wall™ System described in Report Number 1507-03 complies with the CBC and CRC and is subject to the conditions of use described in this supplement.
- 3.2 Where there are variations between the IBC and IRC and the CBC and CRC applicable to this TER, they are listed here:
 - 3.2.1 No variations.

4 Conditions of Use

- 4.1 BamCore® Prime Wall™ System described in Report Number 1507-03, must comply with all of the following conditions:
 - 4.1.1 All applicable sections in Report Number 1507-03.
 - 4.1.2 The design, installation, and inspections are in accordance with additional requirements of the CBC, CRC, and CEC, as applicable.

LABC and LARC Supplement to Report Number 1507-03

REPORT HOLDER: Global Bamboo Technologies Inc.

1 Evaluation Subject

- 1.1 BamCore® Prime Wall™ System

2 Purpose and Scope

2.1 Purpose

- 2.1.1 The purpose of this supplement is to show BamCore® Prime Wall™ System, recognized in Report Number 1507-03, has also been evaluated for compliance with the codes listed below as adopted by the Los Angeles Department of Building and Safety (LADBS).

2.2 *Applicable Code Editions*

- 2.2.1 *LABC—17, 20: Los Angeles Building Code*
- 2.2.2 *LARC—17, 20: Los Angeles Residential Code*

3 Conclusions

- 3.1 BamCore® Prime Wall™ System, described in Report Number 1507-03, complies with the LABC and LARC and is subject to the conditions of use described in this supplement.
- 3.2 Where there are variations between the IBC and IRC and the LABC and LARC applicable to this report, they are listed here:
 - 3.2.1 LABC Section 91.104.2.6 replaces IBC Section 104.11
 - 3.2.2 LARC Section 91.104.2.6 replaces IRC Section R104.11
 - 3.2.3 LABC Section 91.104.2.2 replaces IBC Section 104.4
 - 3.2.4 LABC Section 91.108 replaces IBC Section 110.4
 - 3.2.5 LARC Section 91.104.2.2 replaces IRC Section R104.4
 - 3.2.6 LARC Section 91.108 replaces IRC Section R109.2
 - 3.2.7 LABC Section 91.104 replaces IBC Section 104
 - 3.2.8 LABC Section 91.108.5 replaces IBC Section 110.3

4 Conditions of Use

- 4.1 BamCore® Prime Wall™ System, described in Report Number 1507-03, must comply with all of the following conditions:
 - 4.1.1 All applicable sections in Report Number 1507-03.
 - 4.1.2 The design, installation, and inspections are in accordance with additional requirements of LABC Chapter 16 and Chapter 17, as applicable.

FBC Supplement to Report Number 1507-03

REPORT HOLDER: Global Bamboo Technologies Inc.

1 Evaluation Subject

- 1.1 BamCore® Prime Wall™ System

2 Purpose and Scope

2.1 Purpose

- 2.1.1 The purpose of this Report Supplement is to show BamCore® Prime Wall™ System, recognized in Report Number 1507-03, has also been evaluated for compliance with the codes listed below as adopted by the Florida Building Commission.

2.2 Applicable Code Editions

- 2.2.1 *FBC-B—20, 23: Florida Building Code – Building (FL 41778)*
- 2.2.2 *FBC-R—20, 23: Florida Building Code – Residential (FL 41778)*

3 Conclusions

- 3.1 BamCore® Prime Wall™ System, described in Report Number 1507-03, complies with the FBC-B and FBC-R and is subject to the conditions of use described in this supplement.
- 3.2 Where there are variations between the IBC and IRC and the FBC-B and FBC-R applicable to this report, they are listed here:
 - 3.2.1 FBC-B Section 104.4 and Section 110.4 are reserved.
 - 3.2.2 FBC-R Section R104 and Section R109 are reserved.
 - 3.2.3 FBC-B Section 1207 replaces IBC Section 1206.
 - 3.2.4 FBC-B Section 1405.3 replaces IBC Section 1404.3.
 - 3.2.5 FBC-B Table 1604.3 replaces IBC Table 1604.3.
 - 3.2.6 FBC-B Section 1609.1.1 replaces IBC Section 1609.1.1.
 - 3.2.7 FBC-B Section 2303.2 replaces IBC Section 2303.2.
 - 3.2.8 FBC-B Section 2306.1 replaces IBC Section 2306.1.
 - 3.2.9 FBC-B Section 2306.3 replaces IBC Section 2306.3.
 - 3.2.10 FBC-R Section R301.2.1 replaces IRC Section R301.2.1.
 - 3.2.11 FBC-R Table R301.7 replaces IRC Table R301.7.
 - 3.2.12 FBC-R Section R302.9 replaces IRC Section R302.9.
 - 3.2.13 FBC-R Section R702.7 replaces IRC Section R702.7.
 - 3.2.14 FBC-R Section R802.1.5 replaces IRC Section R802.1.5.

4 Conditions of Use

- 4.1 BamCore® Prime Wall™ System, described in Report Number 1507-03, must comply with all of the following conditions:
 - 4.1.1 All applicable sections in Report Number 1507-03.
 - 4.1.2 The design, installation, and inspections are in accordance with additional requirements of FBC-B Chapter 16 and Chapter 17, as applicable.

Notes

- i For more information, visit drjcertification.org or call us at 608-310-6748.
- ii <https://up.codes/viewer/wyoming/ibc-2021/chapter/17/special-inspections-and-tests#1702>
- iii Alternative Materials, Design and Methods of Construction and Equipment: The provisions of any regulation code are not intended to prevent the installation of any material or to prohibit any design or method of construction not specifically prescribed by a regulation. Please review <https://www.justice.gov/atr/mission> and <https://up.codes/viewer/colorado/ibc-2021/chapter/1/scope-and-administration#104.11>
- iv <https://up.codes/viewer/wyoming/ibc-2021/chapter/17/special-inspections-and-tests#1706>:--:text=the%20design%20strengths%20and%20permissible%20stresses%20shall%20be%20established%20by%20tests%20as
- v The design strengths and permissible stresses of any structural material shall conform to the specifications and methods of design of accepted engineering practice. <https://up.codes/viewer/wyoming/ibc-2021/chapter/17/special-inspections-and-tests#1706>:--:text=shall%20conform%20to%20the%20specifications%20and%20methods%20of%20design%20of%20accepted%20engineering%20practice
- vi <https://up.codes/viewer/wyoming/ibc-2021/chapter/17/special-inspections-and-tests#1707.1>:--:text=the%20building%20official%20shall%20accept%20duly%20authenticated%20reports%20from%20approved%20agencies
- vii <https://up.codes/viewer/wyoming/ibc-2021/chapter/17/special-inspections-and-tests#1703.4.2>
- viii https://up.codes/viewer/wyoming/ibc-2021/chapter/2/definitions#approved_agency
- ix https://up.codes/viewer/wyoming/ibc-2021/chapter/2/definitions#approved_source
- x <https://www.law.cornell.edu/uscode/text/18/1832> (b) Any organization that commits any offense described in subsection (a) shall be fined not more than the greater of \$5,000,000 or 3 times the value of the stolen trade secret to the organization, including expenses for research and design and other costs of reproducing the trade secret that the organization has thereby avoided. The federal government and each state have a public records act. To follow DTSA, and comply state public records and trade secret legislation, requires approval through ANAB ISO/IEC 17065 accredited certification bodies or approved sources. For more information, please review this website: [Intellectual Property and Trade Secrets](https://www.intellectualpropertyandtradesecrets.com).
- xi <https://www.nspe.org/resources/issues-and-advocacy/professional-policies-and-position-statements/regulation-professional> AND <https://apassociation.org/list-of-engineering-boards-in-each-state-archive/>
- xii <https://www.cbiteest.com/accreditation/>
- xiii <https://up.codes/viewer/colorado/ibc-2021/chapter/1/scope-and-administration#104>:--:text=to%20enforce%20the%20provisions%20of%20this%20code
- xiv <https://up.codes/viewer/colorado/ibc-2021/chapter/1/scope-and-administration#104.11>:--:text=Where%20the%20alternative%20material%20design%20or%20method%20of%20construction%20is%20not%20approved%20or%20the%20building%20official%20shall%20respond%20in%20writing%20stating%20the%20reasons%20why%20the%20alternative%20was%20not%20approved AND <https://up.codes/viewer/colorado/ibc-2021/chapter/1/scope-and-administration#105.3.1>:--:text=If%20the%20application%20or%20the%20construction%20documents%20do%20not%20conform%20to%20the%20requirements%20of%20pertinent%20laws%20or%20the%20building%20official%20shall%20reject%20such%20application%20in%20writing%20stating%20the%20reasons%20therefore
- xv <https://up.codes/viewer/colorado/ibc-2021/chapter/17/special-inspections-and-tests#1707.1>:--:text=the%20building%20official%20shall%20accept%20duly%20authenticated%20reports%20from%20approved%20agencies%20in%20respect%20to%20the%20quality%20and%20manner%20of%20use%20of%20new%20materials%20or%20assemblies%20as%20provided%20for%20in%20Section%20104.11
- xvi <https://iaf.nu/en/about-iaf-mia/#>:--:text=it%20is%20required%20to%20recognise%20certificates%20and%20validation%20and%20verification%20statements%20issued%20by%20conformity%20assessment%20bodies%20accredited%20by%20all%20other%20signatories%20of%20the%20IAF%20MLA%20with%20the%20appropriate%20scope
- xvii True for all ANAB accredited product evaluation agencies and all International Trade Agreements.
- xviii <https://www.justice.gov/crt/deprivation-rights-under-color-law> AND <https://www.justice.gov/atr/mission>
- xix Unless otherwise noted, all references in this Listing are from the 2021 version of the codes and the standards referenced therein. This material, product, design, service and/or method of construction also complies with the 2000-2021 versions of the referenced codes and the standards referenced therein.
- xx All references to the CBC and CRC are the same as the 2021 IBC and 2021 IRC, respectively, unless otherwise noted in the supplement at the end of this document.
- xxi All references to the LABC and LARC are the same as the 2021 IBC and 2021 IRC, respectively, unless otherwise noted in the supplement at the end of this document.
- xxii All references to the FBC-B and FBC-R are the same as the 2021 IBC and 2021 IRC unless otherwise noted in the Florida Supplement.
- xxiii All references to the NYSBC-B and NYSBC-R are the same as the 2021 IBC and 2021 IRC
- xxiv <https://www.ecfr.gov/current/title-24/subtitle-B/chapter-XX/part-3280#p-3280.2>(Listed%20or%20certified); <https://up.codes/viewer/colorado/ibc-2021/chapter/2/definitions#listed> AND <https://up.codes/viewer/colorado/ibc-2021/chapter/2/definitions#labeled>
- xxv 2015 IBC Section 1405.3
- xxvi <https://up.codes/viewer/colorado/ibc-2021/chapter/17/special-inspections-and-tests#1703.4>
- xxvii <https://www.ecfr.gov/current/title-24/subtitle-B/chapter-XX/part-3280#>:--:text=All%20construction%20methods%20shall%20be%20in%20conformance%20with%20accepted%20engineering%20practices%20to%20insure%20durable%20livable%20and%20safe%20housing%20and%20shall%20demonstrate%20acceptable%20workmanship%20reflecting%20journeyman%20quality%20of%20work%20of%20the%20various%20trades
- xxviii <https://www.ecfr.gov/current/title-24/subtitle-B/chapter-XX/part-3280#>:--:text=The%20strength%20and%20rigidity%20of%20the%20component%20parts%20and/or%20the%20integrated%20structure%20shall%20be%20determined%20by%20engineering%20analysis%20or%20by%20suitable%20load%20tests%20to%20simulate%20the%20actual%20loads%20and%20conditions%20of%20application%20that%20occur
- xxix 2015 IBC Section 1405.3

- xxxx Qualification is performed by a legislatively defined Accreditation Body. ANSI National Accreditation Board (ANAB) is the largest independent accreditation body in North America and provides services in more than 75 countries. DrJ is an ANAB accredited product certification body.
- xxxi See Code of Federal Regulations (CFR) Title 24 Subtitle B Chapter XX Part 3280 for definition.
- xxxii 2018 IFC Section 104.9
- xxxiii Approved is an adjective that modifies the noun after it. For example, Approved Agency means that the Agency is accepted officially as being suitable in a particular situation. This example conforms to IBC/IRC/IFC Section 201.4 where the building code authorizes sentences to have an ordinarily accepted meaning such as the context implies.
- xxxiv <https://up.codes/viewer/wyoming/ibc-2021/chapter/17/special-inspections-and-tests#1707.1>
- xxxv Multilateral approval is true for all ANAB accredited product evaluation agencies and all International Trade Agreements.
- xxxvi <http://www.drjengineering.org/AppendixC> AND <https://www.drjcertification.org/cornell-2016-protection-trade-secrets>
- xxxvii <https://www.law.cornell.edu/uscode/text/18/1832#:~:text=imprisoned%20not%20more%20than%2010%20years>
- xxxviii <https://www.law.cornell.edu/uscode/text/18/1832#:~:text=Any%20organization%20that,has%20thereby%20avoided>
- xxxix <https://up.codes/viewer/wyoming/ibc-2021/chapter/17/special-inspections-and-tests#1706.2>
- xl IBC 2021, Section 1706.1 Conformance to Standards
- xli IBC 2021, Section 1707 Alternative Test Procedure, 1707.1 General
- xlii See Section 11 for the distilled building code definition of **Approved**
- xliii Los Angeles Municipal Code, SEC. 98.0503. TESTING AGENCIES
- xliv <https://up.codes/viewer/california/ca-building-code-2022/chapter/17/special-inspections-and-tests#1707.1>
- xlv New York City, The Rules of the City of New York, § 101-07 Approved Agencies
- xlvi New York City, The Rules of the City of New York, § 101-07 Approved Agencies
- xlvii <https://up.codes/viewer/new-jersey/ibc-2018/chapter/17/special-inspections-and-tests#1707.1>
- xlviii <https://www.nj.gov/dca/divisions/codes/codreg/ucc.html>
- xlix <https://www.ecfr.gov/current/title-24/subtitle-B/chapter-XX/part-3282/subpart-A/section-3282.14>
- i <https://www.ecfr.gov/current/title-24/subtitle-B/chapter-XX/part-3280>
- ii IBC 2021, Section 1706 Design Strengths of Materials, 1706.2 New Materials. Adopted law pursuant to IBC model code language 1706.2.
- iii IBC 2021, Section 1707 Alternative Test Procedure, 1707.1 General. Adopted law pursuant to IBC model code language 1707.1.
- iiii <https://www.nspe.org/resources/issues-and-advocacy/professional-policies-and-position-statements/regulation-professional> AND <https://apassociation.org/list-of-engineering-boards-in-each-state-archive/>
- lv IBC 2021, Section 1706 Design Strengths of Materials, Section 1706.1 Conformance to Standards Adopted law pursuant to IBC model code language 1706.1.
- lvi <https://iaf.nu/en/about-iaf-mia/#:~:text=it%20is%20required%20to%20recognise%20certificates%20and%20validation%20and%20verification%20statements%20issued%20by%20conformity%20assessment%20bodies%20accredited%20by%20all%20other%20signatories%20of%20the%20IAF%20MLA%2C%20with%20the%20appropriate%20scope>
- lvii True for all ANAB accredited product evaluation agencies and all International Trade Agreements.
- lviii <https://www.justice.gov/crt/deprivation-rights-under-color-law> AND <https://www.justice.gov/atr/mission>